

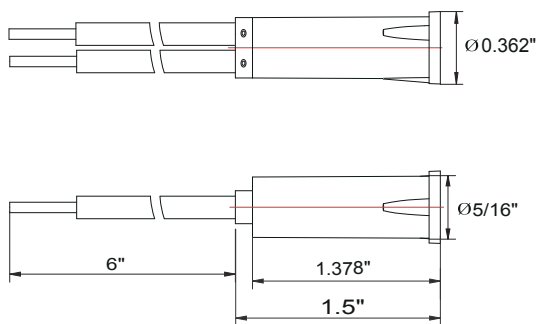



IL 系列指示灯

选型指南:

IL 1	F	-	120	E	-	G	-	U6	-	
安装孔径	选项		工作电压	灯泡类型		颜色		端子形式		防护等级
1: 5/16"	E: 凸头		5: 5V	E: LED		G: 绿色		Q: 快接端子 0.187"		空白: IP40
2: 8mm	F: 平头		12: 12-14V	C: 白炽灯		R: 红色		Q2: 快接端子 0.25"		V: IP65
3: 12mm			24: 24-28V	N: 霓虹灯		A: 橙色		U6: 6英寸导线		
			48: 48V			Y: 黄色		M15: 15cm 导线		
			120: 120V			B: 蓝色				
			240: 240V			W: 白色				
						C: 透明				

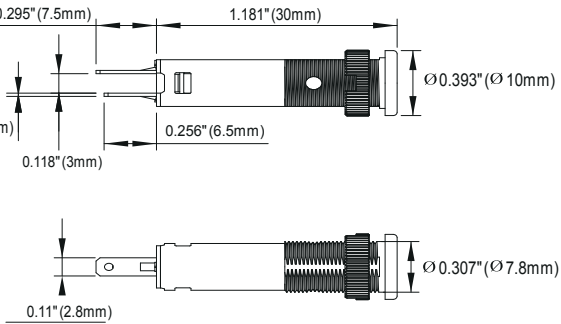
产品尺寸:

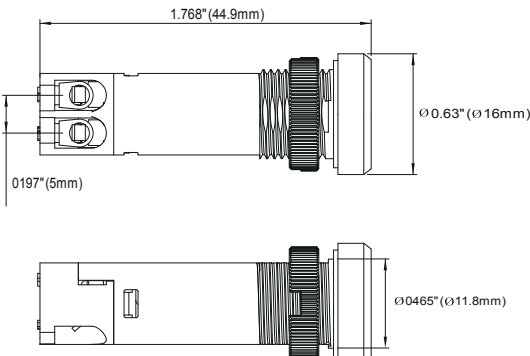
<p>IL1F 防护等级: IP40</p> 	
<p>IL2F 防护等级: IP40/IP65(密封款)</p> 	
<p>IL3E 防护等级: IP40/IP65(密封款)</p> 	

IL4 系列指示灯

特点

- 多种可选电压
- LED节能灯
- 反向电压保护
- UL 列名编号 E216958
- 防护等级可达 IP67
- 可选快接端子用于简易安装
- 适用面板厚度 0.030" 到 0.093"

规格

安装孔径	Ø0.500"(Ø12.7mm)
工作电流	3E(3V AC/DC): 9mA 5E(5V AC/DC): 10mA 6E(6V AC/DC): 18mA 12E(12V AC/DC): 17mA 24E(24V AC/DC): 12mA 120E(120V AC/DC): 5mA 240E(240V AC/DC): 5mA
工作温度	-40~+85°C (-40~+185°F)
寿命	100,000 小时
防护等级	IP67 对于 -V -W 型号
面板厚度	0.030" 到 0.093"

选型指南:

IL 4	E	-	120 E	-	G	-	U6	-	W
安装孔径	选项		工作电压		颜色		端子形式		密封
4: 1/2"	E: 凸头 F: 平头		3: 3V AC/DC 5: 5-7V AC/DC 6: 5-7V AC/DC 12: 12-14V AC/DC 24: 19-28V AC/DC 120: 100-140V AC/DC 240: 200-280V AC/DC		G: 绿色 R: 红色 A: 橙色 Y: 黄色 B: 蓝色 W: 白色		Q: 快接端子 0.189" Q2: 快接端子 0.25" U6: 6英寸导线 M15: 15厘米导线		空: 无密封 V: 面板密封 W: 全密封

尺寸图:

IL4E 凸头式:



密封款 -Q 快接端子 0.189"

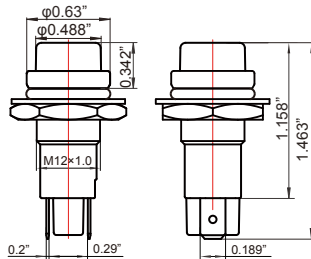

无密封款 -Q 快接端子 0.189"

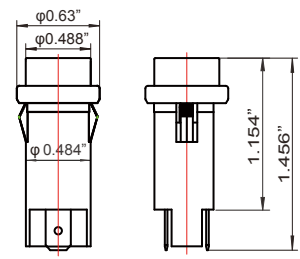

密封款 -Q2 快接端子 0.25"

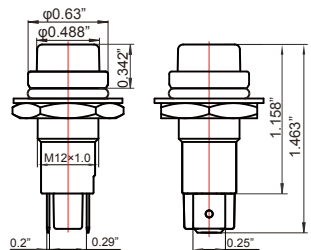

密封款 -U6 6英寸导线

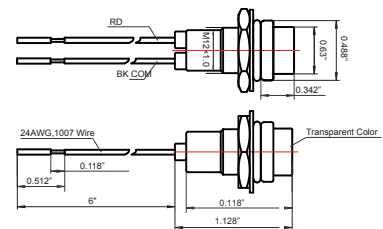

IL4F 平头式:



密封款 -Q 快接端子 0.189"

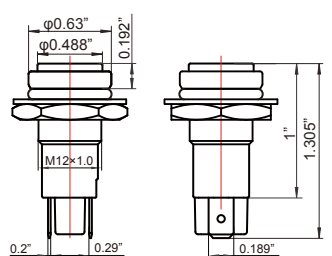

密封款 -Q2 快接端子 0.25"

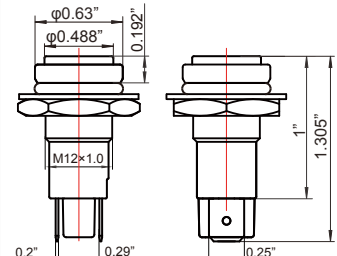

IL5 系列指示灯

特点

- 多种可选电压
- LED节能灯
- 反向电压保护
- UL 列名编号 E216958
- 防护等级IP65

应用

- 可选快接端子用于简易安装
- 适用面板厚度小于 0.025"

规格

安装孔径	Ø0.708"(Ø18mm)
工作电流	10mA(最大)
内部电阻阻值	24E (19-28V AC/DC): 2.2K Ohm 48E (35-56V AC/DC): 4.5K Ohm 120E (100-140V AC/DC): 13K Ohm 240E (200-280V AC/DC): 36K Ohm
工作温度	-40~+85°C (-40~+185°F)
寿命	100,000 小时
防护等级	IP65

选型指南:

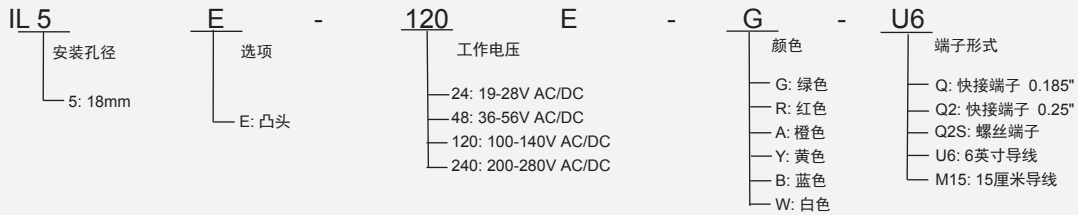

尺寸图:

IL5E-*E-*-Q:

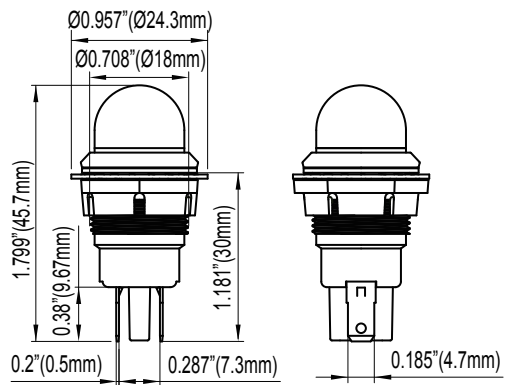

IL5E-*E-*-Q2S:

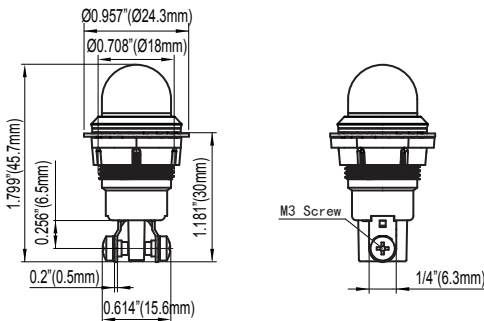

更换零件:

IL5-02G	绿色透镜盖
IL5-02R	红色透镜盖
IL5-02Y	黄色透镜盖
IL5-02A	橙色透镜盖
IL5-02W	白色透镜盖
IL5-02B	蓝色透镜盖